



New Product Guide



America's Best Value in Cabinetry®

2026



Glencove



Dover

New Doors



Woodbourne

Dover

BEDFORD

BY CNG CABINETS

Specifications

Overlay	Standard Overlay: 1" Reveal
Door Style:	2" Wide Shaker
Sides:	Matching paper finished sides included
Hardware:	Soft-close hinges and epoxy side mounted drawer glides
Box Construction:	1/2" thick plywood, light maple laminated interior
Drawer Box:	4-sided box, 1/2" plywood sides
SKU Nomenclature:	D10-B30



Saddle
D07



White
D10







Glencove

LUXOR
BY CNC CABINETRY

Specifications

Overlay	Full Overlay: ¼" Reveal
Door Style:	2 ½" Wide Shaker, 5 Piece Drawer
Sides:	Matching paper finished sides included
Hardware:	Soft-close adjustable hinges and full extension drawer glides
Box Construction:	1/2" thick plywood, light maple laminated interior
Drawer Box:	5/8" solid wood dovetail sides, 3/8" thick bottom
SKU Nomenclature:	G10-B30



Sleek White
G01



Saddle
G07



White
G10



Woodbourne +

Classic
BY CNC CABINETRY

Specifications

Overlay	Frameless: 1/8" Reveal
Door Style:	3" Wide Shaker
Sides:	3/4" Applied or integrated Finished ends (Finished sides by request)
Hinge:	blum soft-close, 6 way adjustable clip-on hinges
Glide:	blum soft-close full extension drawer glides
Box Construction:	Maple Box: 3/4" thick plywood laminated maple wood-grain White Satin Box: 3/4" thick plywood laminated white satin
Drawer Box:	Maple Box: 3/4" solid wood dovetail construction White Satin Box: Double wall white metal drawer box
SKU Nomenclature:	Maple Box: Paint: WBMP-B30 / Specify color number Stain: WKMP-B30 / Specify color number White Satin Box: Paint: WBWP-B30 / Specify color number Stain: WKWP-B30 / Specify color number

Upgrades:
Matching edge band

***This door style is available with an extended lead time.**



White
WB10



Smoky Grey
WKPO2



Stone
WKP23

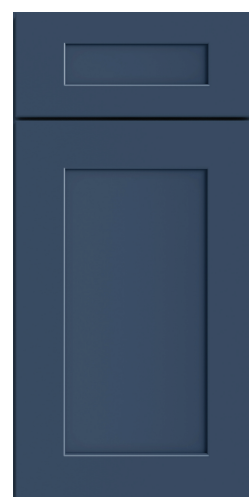

Ocean
WBP27



Sleek White
WBP101

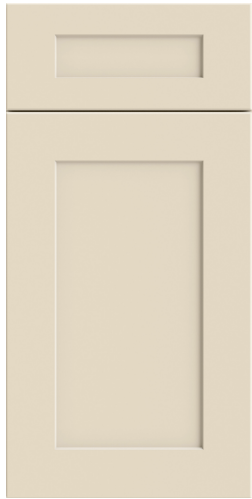

Linen
WBP102

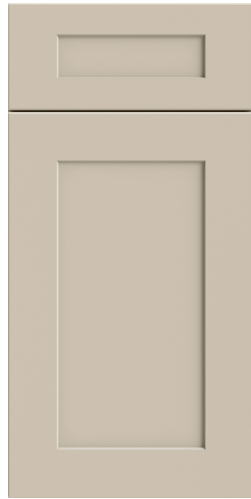

Sahara
WBP103

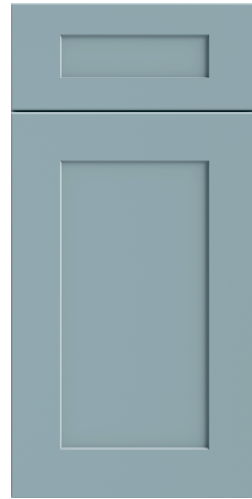

Mountain Stream
WBP104



Adirondack Blue
WBP105



Sage
WBP106



Evergreen
WBP107

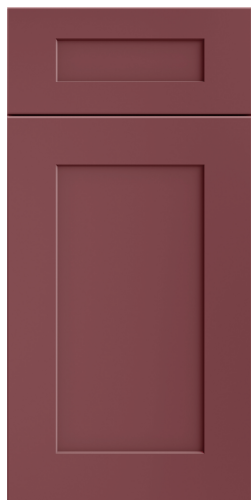

Rumors
WBP108



Cracked Pepper
WBP109



Black
WBP110

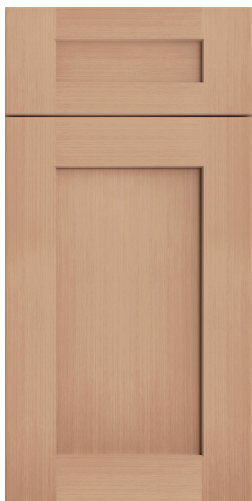

Ale
WKP200



Bourbon
WKP201



Wheat
WKP202

NEW
COLOR







New Items



Reeded Door Insert

Newport & Versailles doors only



Can be applied to both doors
& drawers.

Available as an upgrade in
white and all PLUS colors for
the Newport & Versailles doors.



Cabinets

Bi-fold Door

*Available in Broadway & Milano only



blum

Blum Hardware (Push-to-open)

Available Left or Right

Must sit on counter



*Bi-fold door stores into one side



Pivot and Slide Doors

*Available in Broadway & Milano only



Must sit on counter
Doors are inset into 3/4" panels



Open Wall Cabinet



18" / 30"



30"
36"
42"

12"

Finished interior comes standard on Open Wall Cabinets.

Available in Concord & Classic Collections.

4 Drawer Base

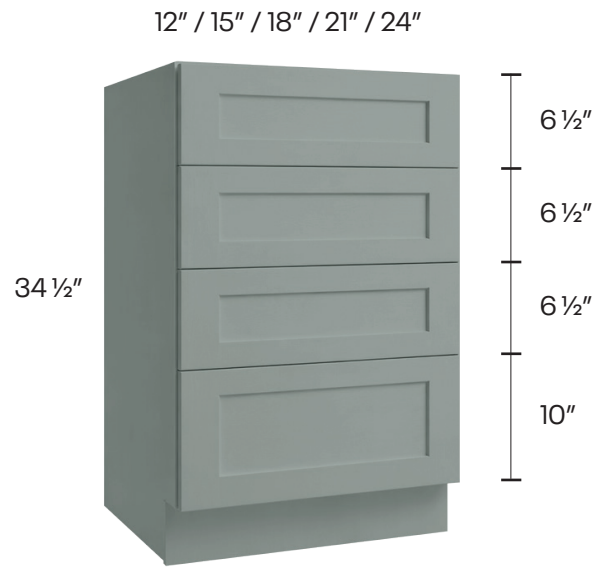

Available in Concord & Classic Collections.

*Not available in the Park Ave door.



Wall Countertop Cabinet

Must sit on counter



Bookcase Cabinet

Finish interior standard
Must sit on counter
No floor



Pantry Cabinet

Available in Classic Collection (Broadway & Milano only)

15" / 18" / 24" / 30"



Moldings

Light Rail Moldings

LTRM2



LTRM3

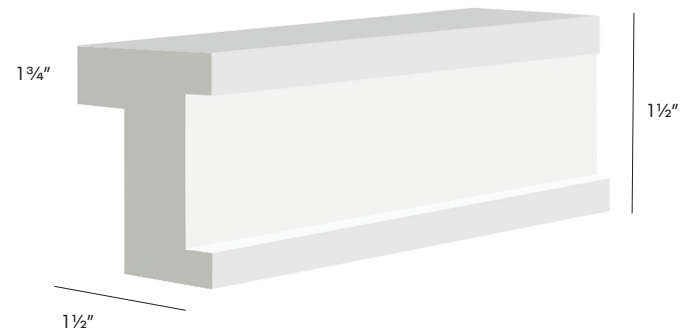

Toe Kick End Cap

Top and bottom finished

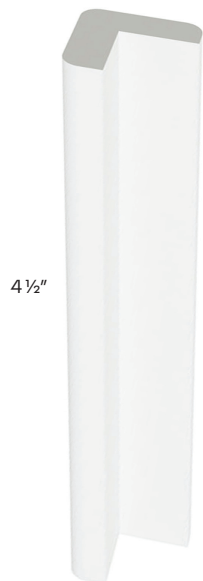

Fillers

Now available in 10' lengths



Accessories

Modern Wood Hood

• Not available in Broadway or Milano

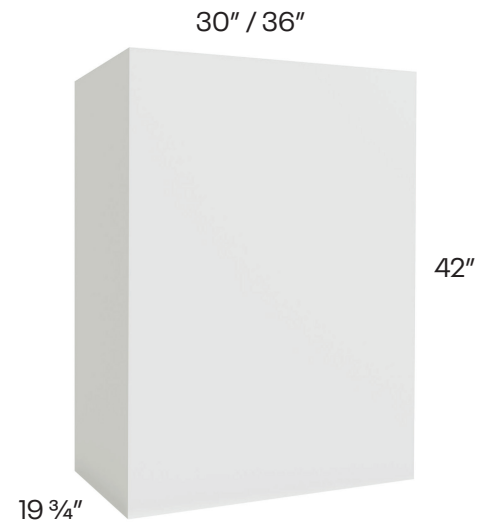

Pull Out Shelf (POS) & Pull Out Drawer (POD)

Old POS



New POS



Custom Items

- Price per square foot
- Customer must provide drawings & dimensions (Width x Height) for custom price quote and lead time
- Can not be combined with existing quote
- Custom items will have an extended lead time
- Grain is always vertical

** Cabinets are made custom, please provide accurate drawings with your order

Wall Cabinet



Base Cabinet

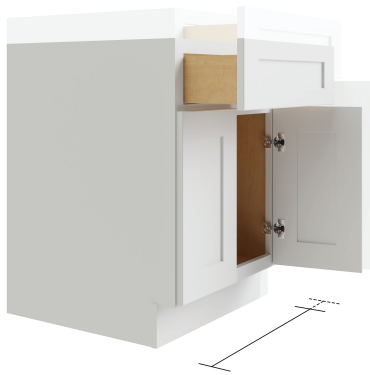

Hood

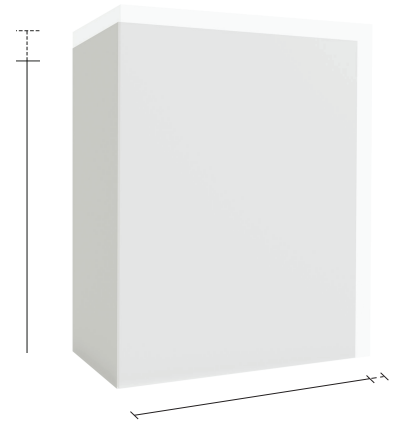

Tall Cabinet



Door / Panel

	Panel	Door
Minimum	6" x 6"	6" x 6"
Maximum	48" x 96"	48" x 96"







New Modifications

Custom Glass Doors

All glass inserts feature a sleek, narrow frame designed for a clean, modern aesthetic. Fully customizable in size, they offer exceptional flexibility to suit a wide range of design requirements and project specifications.

*All frame options are .81" x .73"

**Glass is 5/32"

Frame Options



Onyx



Artic Silver



Gold

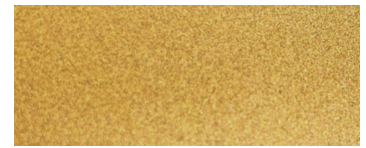

Modern Brass

Glass Options



Low Iron Clear Glass

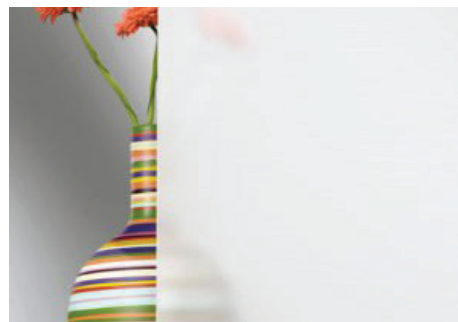

Satin Glass



Standard Reeded Glass



Narrow Reeded Glass



Brown Clear Glass

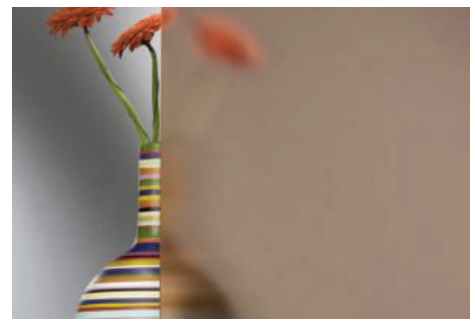

Brown Satin Glass

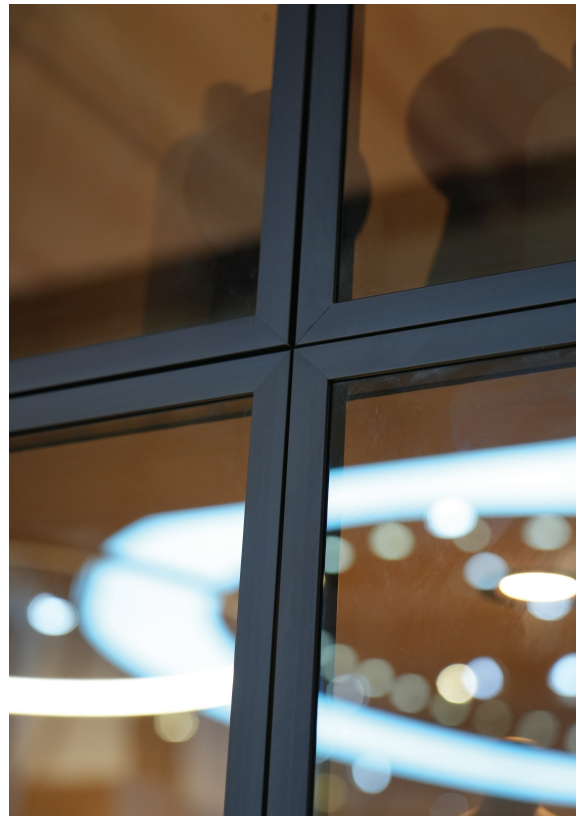

Remove Cabinet Floor



Contrast Finished Interior



Glass Shelves

Available in sets of three shelves with clips.
Available for 12", 15", 18", 24", 30", 36" cabinets.



Broom Divider

Classic Collection

Concord Collection



Member



www.cnccabinetry.com

Headquarters

101 Kentile Road
South Plainfield, NJ 07080

